

# Site manual

Resin technical  
coverings

- Wallcrete
- Wallpaper
- Patina

**kerakoll**



## Contents

### Resin technical coverings

Wallcrete	06
Wallpaper	22
Patina	38



# Resin technical coverings

Wallcrete  
Wallpaper  
Patina

## Use

---

Technical walls (bathrooms, shower interiors and kitchens) in domestic and commercial environments.

# Wallcrete

Water based resin covering with a coloured trowelled material texture.

The matt and monochromatic surface of Wallcrete is characterized by irregularities and textured details resulting from an exclusive hand-made processing that enhances the natural vibration of colours.



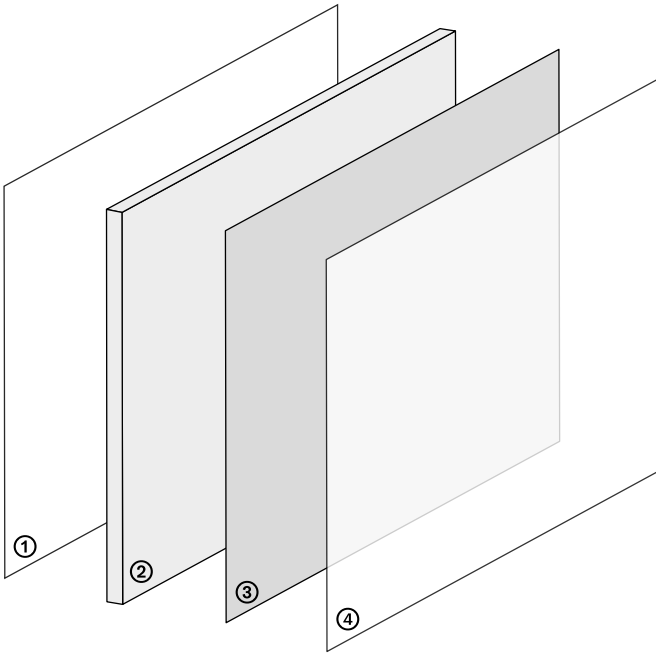

① Layer → Priming according to the substrate

**Universal Wall Primer**  
**Keragrip Eco Pulep**

② Layer → Skimming

**Wallcrete**

③ Layer → Coloured finish

**Decor**

④ Layer → Transparent protective

**Microresina Xtreme Invisible**

# ① Layer → Priming

## Preparation

### Warnings about substrates

- The substrates must be permanently dry and free from rising damp
- Maximum residual moisture on cement based and ceramic substrates: < 2%
- Maximum residual moisture on gypsum and anhydrite based substrates: < 1%
- Temperature range for application: from +10 °C to +30 °C
- Relative environmental humidity: ≤ 75%

### Suitable substrates

- Cement based plasters and finishing products, lime and gypsum
- Substrates made with plasterboard and fibre-cement panels
- Ceramic, glass mosaic and natural stone previous coatings
- Plywood and MDF panels



## Universal Wall Primer

Water based universal primer for walls.



### Products

Pack - 1 l - 5 l - 10 l



### Coverage

≈ 150 - 200 ml/m<sup>2</sup>



### Tools

Brush and roller



### Time

Waiting time for overlaying:  
≈ 4 - 6 hours

## Keragrip Eco Pulep

Organic preparation coat for treatment and cleaning of non-absorbent substrates.



### Products

Pack - 1 l - 10 l



### Coverage

≈ 30 ml/m<sup>2</sup>

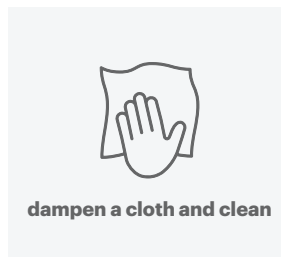

### Tools

Cloth

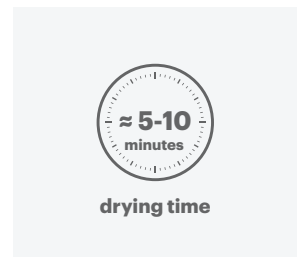

### Time

Waiting time for overlaying:  
≈ 5 - 10 minutes

# ② Layer → Skimming

## Preparation

### Ready-to-use

→ Remix the product inside the container to ensure the mixture is of an even consistency.

## Wallcrete

Texturizing base finishing coat for **Wallcrete** resin covering.



### Products

Pack – 5 kg - 15 kg



### Coverage

≈ 3.0 kg/m<sup>2</sup> for three coats

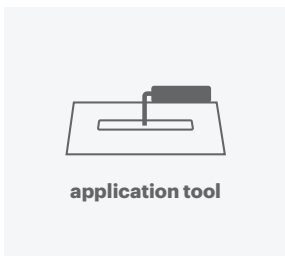

### Tools

Trowel

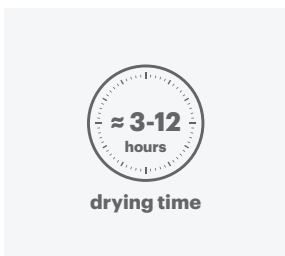

### Time

Once the material has hardened: ≈ 3 - 12 hours

## ② Layer → Skimming

Wallcrete



→ Apply the 1<sup>st</sup> coat of **Wallcrete** spreading it out completely in order to grout the joints, any unevenness of the ceramic tiles or defects of the wall.

→ The 2<sup>nd</sup> coat has the purpose to completely cover the substrate defects and even the wall.

Tip: on walls presenting traces, cracks or unstable crazing, insert Net 90 reinforcing mesh in the 1<sup>st</sup> coat of Wallcrete.

If any wall need to be corrected or levelled, order Wallzero.

→ In order to speed up drying times (especially in damp environments and/or with little air circulation), the use of a fan is recommended.



- Apply the 3<sup>rd</sup> coat once the material has hardened (3 - 12 hours).
- The 3<sup>rd</sup> coat has the purpose to define the final texture of the **Wallcrete** surface; therefore, it is necessary to spread the product smoothing it out completely with small and even strokes of the spreader.

Tip: in order to improve the visibility of the processing, Wallcrete in paste form can be coloured by adding a few drops of Decor of the same shade as the final colour.

# ③ Layer → Coloured finish

## Preparation

### Ready-to-use

→ Remix the product inside the container to ensure the mixture is of an even consistency.

## Decor

Water based decorative resin-paint with washable and wipeable matt-finish and high chromatic intensity.



### Products

Pack – 1,5 l - 4 l - 10 l



### Coverage

≈ 200 ml/m<sup>2</sup> for two coats

Dilution – max 5 - 10%

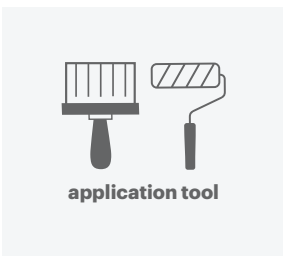

### Tools

Brush and roller

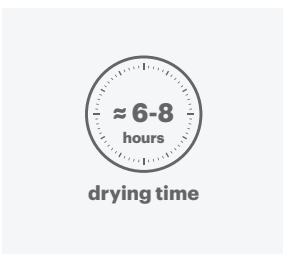

### Time

Waiting time between 1<sup>st</sup> and 2<sup>nd</sup> coat: ≥ 6 hours

### ③ Layer → Coloured finish

Decor



- After 4 - 6 hours from the **Wallcrete** application, sand the surface with 80 - 120-grain sandpaper in order to remove any small imperfections and to make the surface smooth and pleasing to the touch.
  - **Decor** must be carefully applied with a roller over the whole surface in 2 coats, either pure or diluted to a maximum of 5 - 10%.
- Tip: proceed with shaping by passing over the laid film while it is still wet.





→ **Leave at least 6 hours between the 1<sup>st</sup> and 2<sup>nd</sup> coats.**

Tip: in cases where different batches of coloured product are used, it is advisable to mix the various quantities together so as to avoid slight differences in tone.

# ④ Layer → Transparent protective

## Preparation

### Warning

- Shake part A before use and pour into a clean container.
- Add the hardening compound whilst stirring in the ratio part A : part B = 10 : 1.
- Mix well, then dilute 10% using clean water and mix again.
- At the end of the cycle, wait for 5 days before direct, continuous contact with water.

## Microresina Xtreme Invisible

Transparent water based micro-resin for the protection of **Wallcrete** technical covering.



### Products

Pack – (1+0.1) l and (2.5+0.25) l



### Coverage

≈ 120 ml/m<sup>2</sup> for two coats

Dilution – max 10 - 15%

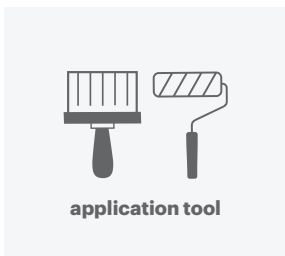

### Tools

Brush and roller

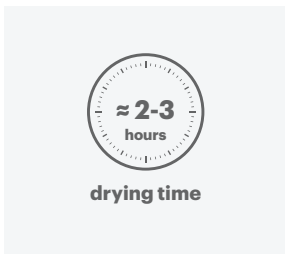

### Time

Waiting time between 1<sup>st</sup> and 2<sup>nd</sup> coat: ≥ 2 - 3 hours

If > 12 hours elapse, sand with **Softpad**

#### ④ Layer → Transparent protective

Microresina Xtreme Invisible



→ Before use, stir part A, add the hardening compound whilst stirring in the ratio part A : part B = 10 : 1.

→ Mix well, then dilute 10% using clean water and mix again.

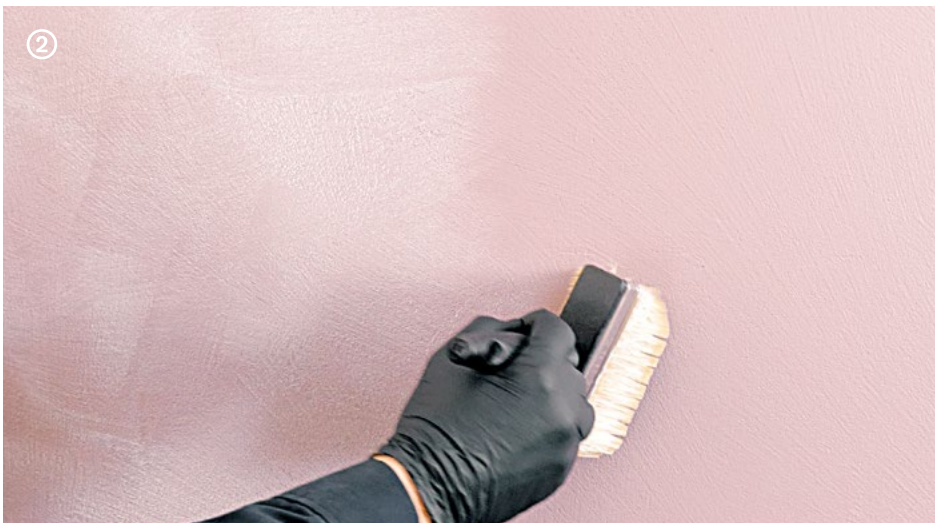

→ Apply 2 coats of **Microresina Xtreme Invisible** with **Roller Plus** or a flat brush respecting the coverage of  $\approx 60 \text{ ml/m}^2$  per coat.

→ Leave between 2 hours (+30 C) and 3 hours (+10 C) before applying the second coat of **Microresina Xtreme Invisible**.

Tip: dilute the first coat to 15%.

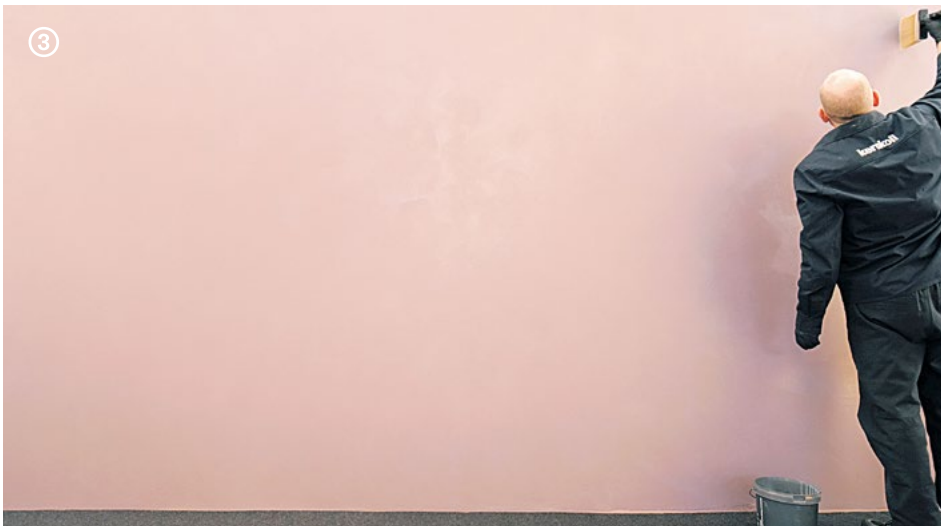

- If the 2<sup>nd</sup> coat is applied within 12 hours it is not necessary to sand the surface.
  - If a period of over 12 hours has passed, sand with **Softpad**.
  - After the application, use **Hyperflex Hybrid** transparent sealant or **Silicone Color** to seal plaques, vents, shower cabinets in environments with frequent contact with water.
- Tip: wait 5 days before direct, continuous contact with water.

# Wallpaper

Water based resin covering with a coloured superflat smooth finish.

The matt and monochromatic surface of Wallpaper is ultra-smooth and silky to the touch. Its essential charm creates a minimalist atmosphere of great elegance and formal purity. Wallpaper is a specific cycle for bathroom and kitchen coverings.



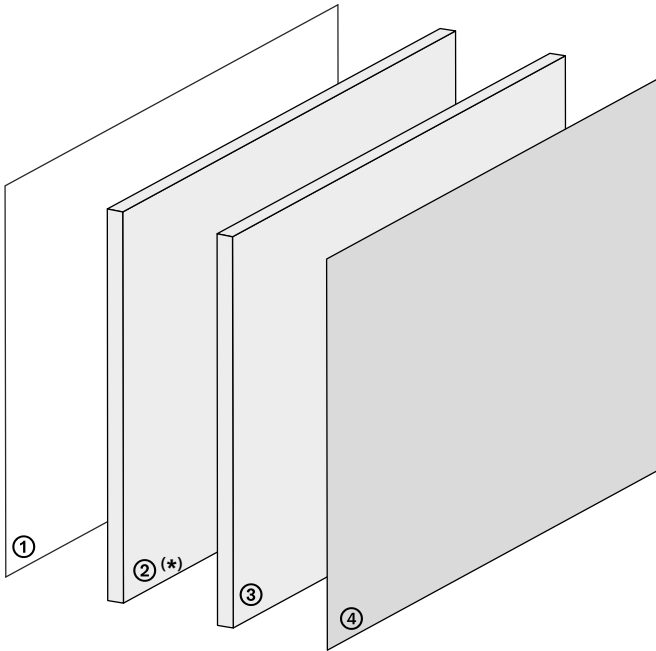

① Layer → Priming → according to substrate

**Universal Wall Primer**

**Keragrip Eco Pulep**

② Layer → Base finishing coat (\*)

**Wallcrete**

(\*) Mandatory finishing coat for shower interiors or irregular substrates such as plasters and ceramic tiles.

③ Layer → Skimming

**Wallpaper**

④ Layer → Coloured finish and protection

**Microresina**

# ① Layer → Priming

## Preparation

### Warnings about substrates

- The substrates must be permanently dry and free from rising damp.
- Maximum residual moisture on cement based and ceramic substrates: < 2%.
- Maximum residual moisture on gypsum and anhydrite based substrates: < 1%.
- Temperature range for application: from +10 °C to +30 °C.
- Relative environmental humidity: ≤ 75%.

### Suitable substrates

- Cement based plasters and finishing products, lime and gypsum.
- Substrates made with plasterboard and fibre-cement panels.
- Ceramic, glass mosaic and natural stone previous coatings.
- Plywood and MDF panels.



## Universal Wall Primer

Water based universal primer for walls.



### Products

Pack – 1 l - 5 l - 10 l



### Coverage

≈ 150 - 200 ml/m<sup>2</sup>



### Tools

Brush and roller



### Time

Waiting time for  
overlaying:  
≈ 4 - 6 hours

## Keragrip Eco Pulep

Organic preparation coat for treatment and cleaning of non-absorbent substrates.



### Products

Pack – 1 l - 10 l



### Coverage

≈ 30 ml/m<sup>2</sup>

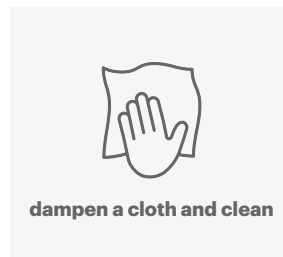

### Tools

Cloth

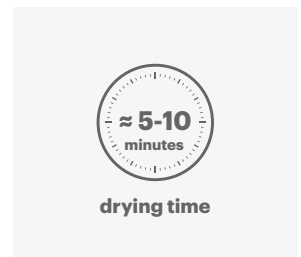

### Time

Waiting time for  
overlaying:  
≈ 5 -10 minutes

# ② Layer → Base finishing coat (\*)

## Preparation

### Ready-to-use

→ Remix the product inside the container to ensure the mixture is of an even consistency.

(\*) Mandatory finishing coat for shower interiors or irregular substrates such as plasters and ceramic tiles.

## Wallcrete

Texturizing base finishing coat for shower interiors or irregular substrates for **Wallpaper** covering.



### Products

Pack – 5 kg - 15 kg



### Coverage

≈ 2.0 kg/m<sup>2</sup> for two coats

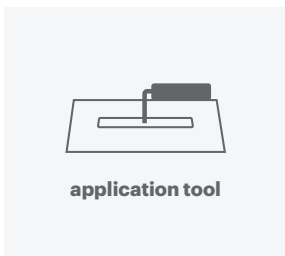

### Tools

Trowel

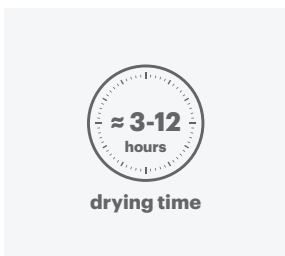

### Time

Once the material has hardened: ≈ 3 - 12 hours

## ② Layer → Base finishing coat (\*)

Wallcrete



→ Apply the 1<sup>st</sup> coat of **Wallcrete** spreading the joints off completely in order to grout them.

→ On plasters or finishing coats, carefully smooth evening the substrate.

Tip: on walls presenting traces, cracks or unstable crazing, insert Net 90 reinforcing mesh in the 1<sup>st</sup> coat of Wallcrete.

If any wall need to be corrected or levelled, order Wallzero.

→ In order to speed up drying times (especially in damp environments and/or with little air circulation), the use of a fan is recommended.



→ The 2<sup>nd</sup> coat has the purpose to completely cover the substrate defects and even the wall.

Tip: if obvious crests or flashes are present, sand in order to remove them before applying the second coat.

# ③ Layer → Skimming

## Preparation

### Ready-to-use

→ Remix before use; the paste must be smooth, consistent and without lumps.

## Wallpaper

Superflat, base performance finishing coat for **Wallpaper** resin covering.



### Products

Pack – 5 kg



### Coverage

≈ 1.5 kg/m<sup>2</sup>

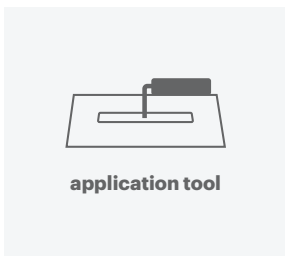

### Tools

Trowel

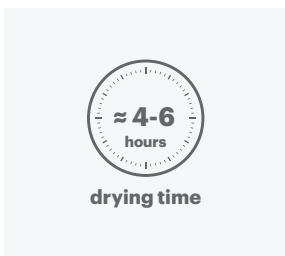

### Time

Waiting time for the sanding and the top application: ≈ 4 - 6 hours

### ③ Layer → Skimming

Wallpaper



→ Apply the 1<sup>st</sup> coat of **Wallpaper** spreading the product on the surface in order to even and level it.

Tip: a drop of water may be added in order to make the product more workable.

If crests or flashes are present, sand in order to remove them before applying the subsequent coat. Apply repeated coats until a perfectly flat surface is obtained.





→ Apply the product on the previous dry coat, until a perfectly even surface is achieved.

→ Before applying **Microresina**, check that the surface is perfectly even; if necessary, apply a further coat.

Tip: we recommend to sand the final coat with a 240-grain sandpaper to achieve a perfectly even surface.

Wait at least 12 hours before re-applying Microresina.

## ④ Layer →

# Coloured finish and protection

### Preparation

#### Warning

- Before use, stir part A, add the hardening compound whilst stirring in the ratio part A : part B = 5 : 1 and mix well until completely blended.
- Dilute using clean water up to 10% and mix again.
- At the end of the cycle, wait for 5 days before direct, continuous contact with water

## Microresina

Coloured water based micro-resin with varnished matt finish for the protection of **Wallpaper** technical covering.



### Products

Pack – (1+0.2) kg and (2.5+0.5) kg



### Coverage

≈ 300 g/m<sup>2</sup> for two-three coats

Dilution – max 10%

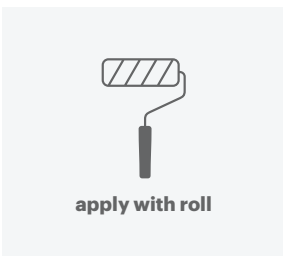

### Tools

Roller

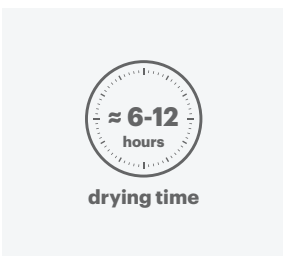

### Time

Waiting time between 1<sup>st</sup> and 2<sup>nd</sup> coat: ≈ 6 - 12 hours (covering)

Waiting time between subsequent coats: ≈ 2 - 12 hours

#### ④ Layer → Coloured finish and protection

Microresina



→ Before use, stir part A, add the hardening compound whilst stirring in the ratio part A : part B = 5 : 1. Mix well, then dilute 10% using clean water and mix again.



→ **Microresina** must be carefully applied with a roller over the whole surface in two-three coats, diluted to a maximum of 10%.

Tip: proceed with shaping by passing over the laid film while it is still wet.



- Help yourself with a spotlight to create a grazing light flush with the wall, and be able to check the perfect evenness of the wall.
- If there are small imperfections, grout promptly with **Wallpaper** before proceeding with the subsequent coats.



- Leave at least 6 hours between the 1<sup>st</sup> and 2<sup>nd</sup> coats.
- Waiting time between subsequent coats ≈ 2 - 12 hours.
- After the application, use **Hyperflex Hybrid** transparent sealant or **Silicone Color** to seal plaques, vents, shower cabinets in environments with frequent contact with water.

# Patina

Water based resin covering with a delabr  plaster texture and natural shaded finish.

The surface of Patina is velvety to the touch and characterized by ripples and material vibrations resulting from the imperfections of hand-made processing.

The uneven colour and the unique effects in light reflection create a sophisticated sense of imperfection.

Patina is a specific cycle for bathroom and kitchen coverings.



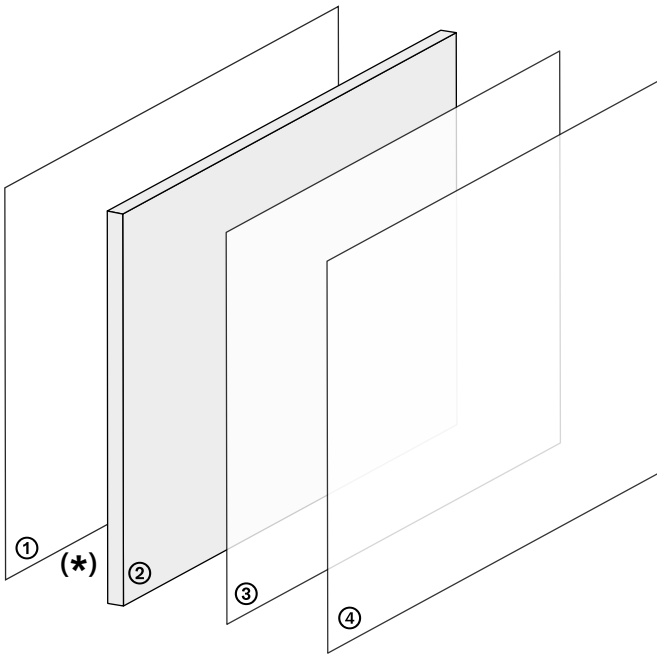

① Layer → Priming → according to substrate

### **Universal Wall Primer**

### **(\*) Keragrip Eco Pulep + Wallcrete**

On substrates made of ceramic, prime with Keragrip Eco Pulep and proceed with a base finishing coat using Wallcrete (see page 23).

② Layer → Skimming

### **Patina**

③ Layer → Impregnating protective product

### **Finish**

④ Layer → Protective finishing

### **Microresina Xtreme Invisible**

# ① Layer → Priming

## Preparation

### Warnings about substrates

- The substrates must be permanently dry and free from rising damp.
- Maximum residual moisture on cement based and ceramic substrates: < 2%.
- Maximum residual moisture on gypsum and anhydrite based substrates: < 1%.
- Temperature range for application: from +10 °C to +30 °C.
- Relative environmental humidity: ≤ 75%.

### Suitable substrates

- Cement based plasters and finishing products, lime and gypsum.
- Substrates made with plasterboard and fibre-cement panels.
- Ceramic, glass mosaic and natural stone previous coatings.
- Plywood and MDF panels.



## Universal Wall Primer

Water based universal primer for walls.



### Products

Pack - 1 l - 5 l - 10 l



### Coverage

≈ 150 - 200 ml/m<sup>2</sup>



### Tools

Brush and roller



### Time

Waiting time for overlaying:  
≈ 4 - 6 hours

## Keragrip Eco Pulep

Organic preparation coat for treatment and cleaning of non-absorbent substrates.



### Products

Pack - 1 l - 10 l



### Coverage

≈ 30 ml/m<sup>2</sup>

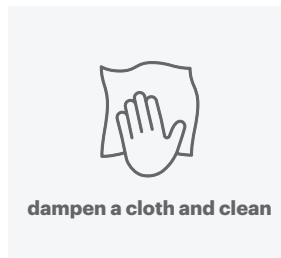

### Tools

Cloth

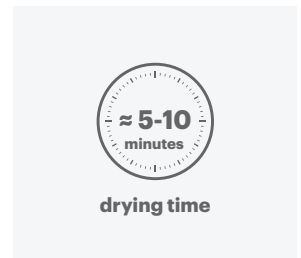

### Time

Waiting time for overlaying:  
≈ 5 - 10 minutes

# ② Layer → Skimming

## Preparation

### Ready-to-use

→ Remix the product inside the container to ensure the mixture is of an even consistency.

## Patina

Water based resin covering with a delabr  plaster texture and natural shaded finish.



### Products

Pack – 15 kg



### Coverage

≈ 3 kg/m<sup>2</sup> for three coats

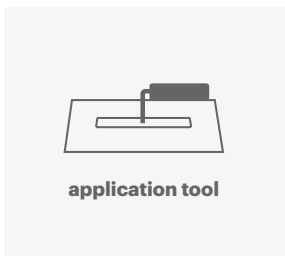

### Tools

Trowel

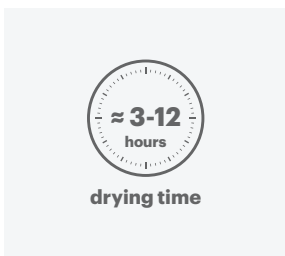

### Time

Once the material has hardened: ≈ 3 - 12 hours

## ② Layer → Skimming

Patina



→ Apply the 1<sup>st</sup> coat of **Patina** spreading the product with small and even strokes of the spreader over the entire surface.

Tip: when applying, keep the spreader flat so as not to leave raised crests or notches.



→ In order to speed up drying times (especially in damp environments and/or with little air circulation), the use of a fan is recommended.



→ **Apply the 2<sup>nd</sup> coat once the material has hardened (3 - 12 hours).**

Tip: if crests or flashes are present, sand in order to remove them before applying the 3<sup>rd</sup> coat. A drop of water may be added in order to make the product more workable.

When applying the 3<sup>rd</sup> coat, add the exact same quantity of water in all mixes in order to avoid differences in colour.

→ **The 3<sup>rd</sup> coat has the purpose to define the final texture of the surface.**

Tip: when applying the 3<sup>rd</sup> coat of Patina, keep the spreader “flat”, that is almost parallel to the wall.

In order to obtain a more compact and natural shaded surface, spread and compact the product with the blade of the spreader during the drying phase (“touch dry”).

# ③ Layer → Impregnating protective product

## Preparation

### Ready-to-use

→ Remix the product inside the container to ensure the mixture is of an even consistency.

## Finish

Protective water based impregnating product for **Patina** resin covering.



### Products

Pack – 1.5 l



### Coverage

≈ 80 ml/m<sup>2</sup> for one coat

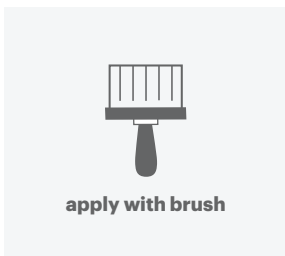

### Tools

Brush

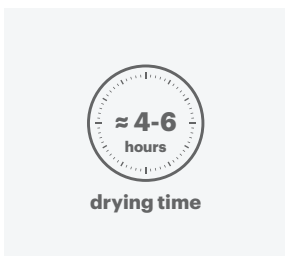

### Time

Waiting time between 1<sup>st</sup> and 2<sup>nd</sup> coat: ≈ 4 - 6 hours

### ③ Layer → Impregnating protective product

Patina



→ Once the coloured texturizing finishing coat **Patina** has completely dried, apply the 1<sup>st</sup> coat of **Finish** by brush without sanding.

Tip: proceed with crossed strokes from the top downwards.





- After 4 - 6 hours, sand the surface with 80 - 120 grain sandpaper in order to remove any small imperfections and to make the surface smooth and pleasing to the touch.
- Remove any dust with a dry flat brush or a cotton cloth and then be ready to apply **Microresina Xtreme Invisible**.

# ④ Layer → Protective finishing

## Preparation

### Warning

- Shake part A before use and pour into a clean container.
- Add the hardening compound whilst stirring in the ratio part A : part B = 10 : 1.
- Mix well, then dilute 10% using clean water and mix again.
- At the end of the cycle, wait for 5 days before direct, continuous contact with water.

## Microresina Xtreme Invisible

Transparent water based micro-resin for the protection of **Patina** technical covering.



### Products

Pack – (1+0.1) l and (2.5+0.25) l



### Coverage

≈ 180 ml/m<sup>2</sup> for three coats

Dilution – max 10 - 15%

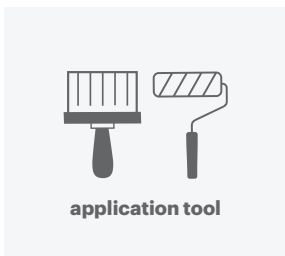

### Tools

Brush and roller

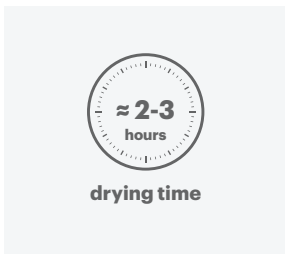

### Time

Waiting time between 1<sup>st</sup> and 2<sup>nd</sup> coat: ≥ 2 - 3 hours

If > 12 hours elapse, sand with **Softpad**

#### ④ Layer → Protective finishing

Microresina Xtreme Invisible



→ Before use, stir part A, add the hardening compound whilst stirring in the ratio part A : part B = 10 : 1.

→ Mix well, then dilute 10% using clean water and mix again.



→ Apply 2 or 3 coats of **Microresina Xtreme Invisible** with **Roller Plus** or a flat brush respecting the coverage of  $\approx 60 \text{ ml/m}^2$  per coat.

→ Waiting time for the overlaying of the 2<sup>nd</sup> and 3<sup>rd</sup> coats of **Microresina Xtreme Invisible**:  $\approx 2 - 3$  hours.

Tip: dilute the 1<sup>st</sup> coat to 15%.



- If the 2<sup>nd</sup> or 3<sup>rd</sup> coats are applied within 12 hours it is not necessary to sand the surface.
  - If a period of over 12 hours has passed, sand with **Softpad**.
  - After the application, use **Hyperflex Hybrid** transparent sealant or **Silicone Color** to seal plaques, vents, shower cabinets in environments with frequent contact with water
- Tip: wait 5 days before direct, continuous contact with water.



# Surfaces and Uses

## Surfaces

---

### Paints

Absolute  
Decor

---

### Resin-based coating materials

**Decorative coverings**  
Wallcrete Living  
Wallpaper Living  
Patina Living  
Stripe Living

### Technical coverings\*

Wallcrete  
Wallpaper  
Patina

---

### Microresina

Microresina  
Microresina Floor  
Microresina Parquet

---

### Cementoresina

Cementoresina  
Cementoresina Wall

---

### Legno+Color

Legno+Color S, M, L

---

### Finishes for external application

Outdoor Paint  
Outdoor Plaster

---

### Skirting board

Invisibile

---



## Use

---

### Walls and ceilings

Absolute  
Decor

---

### Decorative walls

Wallcrete Living  
Wallpaper Living  
Patina Living  
Stripe Living

---

### Technical walls\*

Wallcrete  
Wallpaper  
Patina  
Cementoresina Wall

---

### Floors

Cementoresina  
Legno+Color S, M, L  
Microresina Floor  
Microresina Parquet

---

### Re-color\*\*

Microresina

---

### External façades

Outdoor Paint  
Outdoor Plaster

\* Walls of bathrooms and kitchens.

\*\* Doors, internal and external fixtures, joinery and ceramic coverings.

N.B.

This Site manual has been drafted on the basis of the best technical and practical knowledge of Kerakoll S.p.A.

It is, however, a set of guides and information of a general nature that do not consider the real situations of individual structures; therefore, the coverage information is to be considered merely indicative.

Kerakoll does not intervene directly in the building site conditions, the specific design of the project, and the execution of the work; the information and guidelines mentioned here do not commit Kerakoll in any way.

The designer in charge is responsible for the entire structural design in accordance with Italian Ministerial Decree 17/01/2018 and its amendments or additions.

All rights reserved. © Kerakoll. All rights to the content of this publication are reserved in accordance with applicable law.

The duplication, publication, and distribution, in full or in part, of all material contained herein, are expressly forbidden without written authorization. Additions and/or amendments to this information may be made over time by KERAKOLL Spa; for the latest version, see [www.kerakoll.com](http://www.kerakoll.com).

KERAKOLL Spa shall therefore be liable for the validity, accuracy and updating of information provided only when taken directly from its institutional website. For information on the product safety data, refer to the corresponding sheets provided in accordance with the law along with the health labelling on the packaging. Finally, it is advisable to perform a preliminary test of each product to verify its suitability for your purposes.

Kerakoll Spa  
via dell'Artigianato 9  
41049 Sassuolo (MO) Italy  
T +39 0536 816 511  
info@kerakoll.com

Kerakoll Brera Studio  
via Solferino 16  
20121 Milano (MI) Italy  
T +39 02 620 867 81

**kerakoll**

[kerakoll.com](http://kerakoll.com)