

Site manual

Cementoresina

- Cementoresina
- Cementoresina Wall

kerakoll

Contents

Cementoresina	06
Floorzero	19
Cementoresina 1	27
Cementoresina 2	31
Cementoresina Gel	35
Microresina Xtreme	41
Cementoresina Wall	
Wallzero	53
Cementoresina Wall	61
Cementoresina Gel	67
Microresina Xtreme	73



Cementoresina

Cementoresina

Use

Cementoresina is ideal for:

- floors, staircases, spas, Turkish baths and shower trays
- for internal use, in domestic and commercial environments.

Suitable for heated substrates.

Cementoresina

Resin floor with a coloured-body trowelled texture and high-performance natural finish.

Cementoresina has a highly aesthetic texture quality characterized by ripples, chromatic marbling and material vibrations resulting from the imperfections of craftsmanship. It creates a fascinating and elegant atmosphere in just 3 mm of thickness.



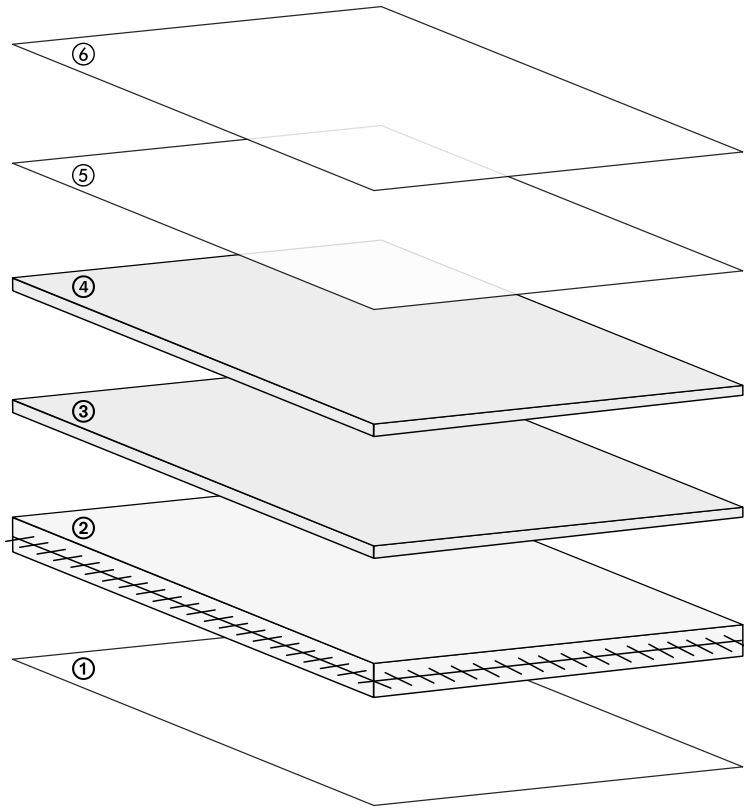

① Layer → Priming, according to the substrate

EP21

Keragrip Eco Pulep

② Layer → Structural substrate

Floorzero + Net 90 + Quarzo 1.3

③ Layer → Base finishing coat

Cementoresina 1

④ Layer → Decorative finishing layer

Cementoresina 2

⑤ Layer → Protective gel

Cementoresina Gel

⑥ Layer → Transparent protective

Microresina Xtreme

① Layer → Priming

Preparation

Warnings about substrates

- The substrates must be dry and free from rising damp.
- Maximum residual moisture on cement-based and ceramic substrates: < 2% (< 1.7% with underfloor heating systems).
- Maximum residual moisture on anhydrite-based substrates: < 0.5% (< 0.2% with underfloor heating systems).
- Temperature range for application from +10 °C to +30 °C.
- Relative environmental humidity ≤ 75%.
- The substrates must have a surface tear strength > 1.5 MPa according to ASTM D 4541 and a compressive strength > 25 N/mm².

Suitable substrates

- Cement-based screeds and self-levelling compounds and reinforced concrete.
- Anhydrite screeds.
- Existing marble, ceramic or similar floors.
- Fibre-cement or gypsum fibreboard dry panelling.
- Cement, dry panelling or metal stairs.

EP21

Eco-friendly, organic preparation coat for priming and consolidating absorbent substrates.



Products

Pack EP21 – (2.5+1) l



Coverage

≈ 200 ml/m² (in 1 coat)
≈ 400 ml/m² (in 2 coats) to consolidate
Dilution with Keragrip
Eco Pulep: max 30%



Tools

Roller

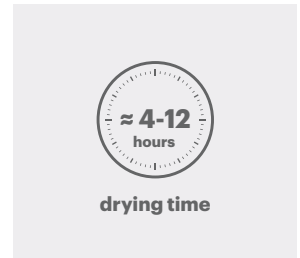

Time

Waiting time for overlying: 4 - 12 hours

Keragrip Eco Pulep

Eco-friendly, organic preparation coat for ceramic coverings.



Products

Pack – 1 l - 10 l



Coverage

≈ 30 ml/m²

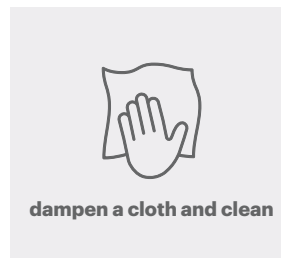

Tools

Cloth

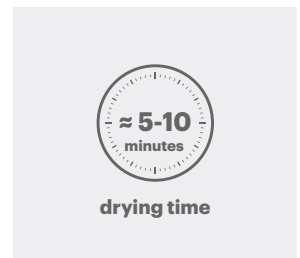

Time

Waiting time for overlying: 5 - 10 minutes

Preparation of substrates

Cementoresina



CEMENT-BASED SCREEDS AND SELF-LEVELLING COMPOUNDS AND REINFORCED CONCRETE

- The substrates must be permanently dry and free from rising damp.
- Cement based substrates must have a residual moisture at a maximum of 2% or 1.7% in case of under floor heating.

Tip: always check residual moisture before starting a building-site in order to avoid any rising damp or infiltrations.

Before starting to work, substrates must be checked in order to assess their suitability according to the indications of the technical data sheet.



→ Cement-based substrates must be suitably sanded (diamond disc/
carborundum/36 grain sandpaper).

① Layer → Priming

Cementoresina



CEMENT-BASED SCREEDS, SELF-LEVELLING COMPOUNDS OR PANELS

→ Cracks, fissures and joints must be defined and cut using an angle grinder with a diamond disc.



→ Remove loose or poorly cohesive debris, carefully vacuum the substrate and clean it from dust or sanding residues.



LEVELLING / CREATING SLOPES

→ Uneven or excessively rough substrates must be corrected with **Keratech Eco Flex** or synthetic mortars (**EP21 + Quarzo 5.12** in a ratio of 1 : 10).

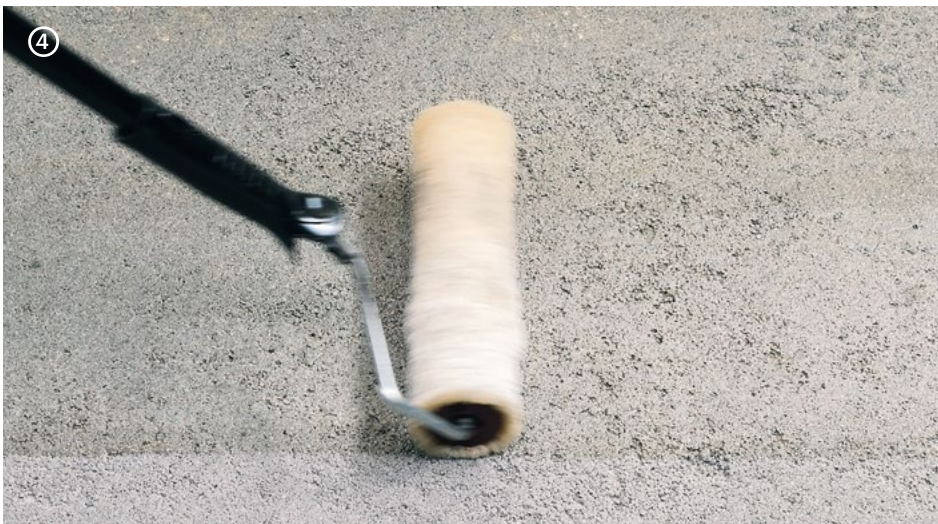

→ The absorbent cement-based substrates must be treated with **EP21** applied neat and spread using a roller with a coverage of $\approx 200 \text{ ml/m}^2$.
Tip: flaky substrates must be treated with 2 coats of EP21. The 1st coat diluted with Keragrip Eco Pulep up to 30%, the 2nd coat, 6 hours later, with pure EP21.

① Layer → Priming

Cementoresina



ANHYDRITE SCREEDS OR GYPSUM FIBREBOARD PANELS

- Anhydrite screeds must have residual moisture of a maximum of 0.5% or 0.2% in case of under floor heating.
- Anhydrite-based screeds must be sanded, cleaned and then treated with **EP21** diluted with **Keragrip Eco Pulep** up to 30%.
- Wait at least 6 hours, then apply the 2nd coat of undiluted product and spread it with a roller with a coverage of $\approx 200 \text{ ml/m}^2$.
- Spread the primer evenly over the surface, avoid creating any build-up.



EXISTING MARBLE, CERAMIC, PORCELAIN TILE FLOORS

- Ceramic substrates must have residual moisture at a maximum of 2% or 1.7% in case of under floor heating.
- Check the moisture in the joints; when in doubt, peel of a tile and check the moisture under the ceramic covering.

① Layer → Priming

Cementoresina



EXISTING MARBLE, CERAMIC, PORCELAIN TILE FLOORS

→ The substrates must be sanded with a suitable diamond disc in order to remove any impurities to guarantee optimal adhesion. Cracks, fissures and joints must be defined and cut using an angle grinder with a diamond disc. After smoothing, remove loose debris or poorly cohesive parts, vacuum and perfectly clean the substrate.

→ Substrates must be treated with **Keragrip Eco Pulep** adhesion promoter: dampen a cloth with it and clean all the flooring.

Tip: wait 30 minutes before the subsequent application. Avoid spilling Keragrip Eco Pulep as it may dampen the joints and cause subsequent problems of rising vapours.



METAL STAIRS

- Metal substrates must be sanded until the metal is visible.
 - Substrates must be treated with **Keragrip Eco Pulep** adhesion promoter: dampen a cloth with it and clean the whole metal surface.
- Tip: in case of rusty areas, use a wire brush to thoroughly eliminate rust or mill scale. Carefully clean the surface again and apply one or two coats of Keradecor Sintcrom rust-preventive, anti-corrosive paint. Wait 24 hours until completely dry before applying subsequent coats.

② Layer → Structural substrate

Preparation

- **Floorzero** is prepared by mixing with a helicoidal agitator, respecting the mixing ratio 9.25 : 0.75. Pour part B into the bucket of part A; be careful to evenly mix both parts.
- After carefully mixing for the first time, run a square-sided trowel along the sides and bottom of the bucket to mix all parts left unmixed by the agitator, then mix again.
- In order to fasten edge beads (stairs, steps or profiles), grout joints and cracks and finish stairs and steps, use **Floorzero** added with **Addensante** (3-5% in weight) so as to make it thixotropic.

Floorzero

Innovative polymer matrix composite structural support for **Cementoresina** floors.



Products

Pack – (9.25+0.75) kg



Coverage

≈ 2.5 kg/m²

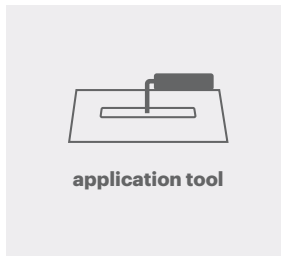

Tools

American spreader

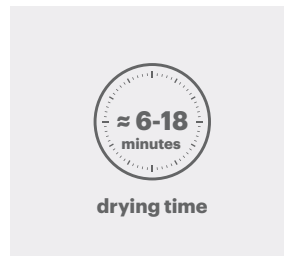

Time

Waiting time for overlaying:
≈ 6 hours (+20 °C)
≈ 18 hours (+10 °C)

Net 90

Reinforcing mesh

Quarzo 1.3

Mineral quartz

Addensante

Thixotropic agent



Products

Pack – 50 m

Coverage ≈ 1 m/m²



Products

Pack – 25 kg

Coverage ≈ 2 kg/m²



Products

Pack – 1 Kg

Coverage (1 package)
≈ 12 - 14 steps

② Layer → Structural substrate

Floorzero



CRACK PREPARATION

→ Cracks, after being prepared with **EP21**, must be grouted and closed with **Floorzero** added with **Addensante** (3-5% in weight).



ISOLATION, PERIMETRIC, CONTRACTION, EXPANSION/ CONSTRUCTION JOINTS

→ Joints must be prepared cutting flush any band and primed with **EP21**; then they must be grouted and closed with **Floorzero** added with **Addensante** (3-5% in weight).

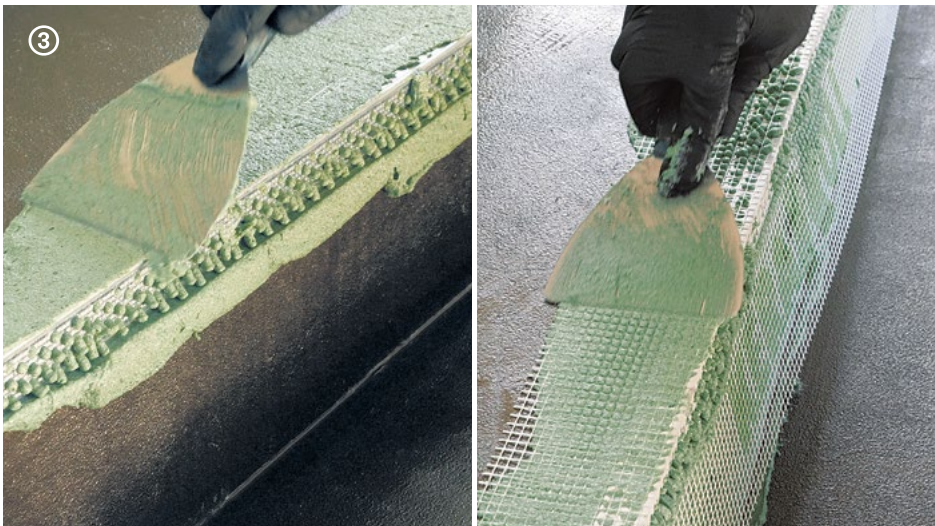

FASTENING OF EDGE BEADS / PROFILES

→ In order to fasten edge beams (stairs, steps or profiles), use **Floorzero** added with **Addensante** (3-5% in weight).

Tip: we recommend using PVC edge beads.

N.B. Galvanized steel sheet edge beads may also be used. When sanding, be particularly careful not to remove the galvanizing.

N.B. all joints and cracks, duly closed as described in the previous page, that need to continue to “work” following the normal expansion of the substrate, can be seen against the light as raised areas or depressions depending on the movement of the substrate.

② Layer → Structural substrate

Floorzero



→ Pour part B into the bucket of part A respecting the mixing ratio 9.25 : 0.75. After carefully mixing for the first time with a helicoidal agitator, run a square-sided trowel along the sides and bottom of the bucket, then mix again.



→ Before applying on the whole flooring, if need be a local preliminary grouting may be carried out in order to repair small, few-millimetre-thick imperfections of the substrate.



→ Spread the **Net 90** fibreglass reinforcing mesh on the whole surface, bringing the edges of the mesh together.



→ Spread the product with a finishing trowel and level to cover the **Net 90** mesh, respecting the coverage of $\approx 2.5 \text{ kg/m}^2$. Pay attention during application to the complete coverage of the glass fibre mesh.

② Layer → Structural substrate

Floorzero



→ In case of a particularly irregular substrate, or in case of deep joints, apply a 2nd coat of **Floorzero** in order to perfectly level the surface.



→ Sprinkle wet on wet to saturation with **Quarzo 1.3** maintaining the coverage of $\approx 2 \text{ kg/m}^2$.

Tip: before the application of the subsequent layer, check that Floorzero is leveled, that defects and imperfections of the substrate have been covered, and that the Net 90 reinforcing mesh is not showing. Carefully check that imperfectly catalysed areas of Floorzero are not present (this can result from incorrect mixing); in case they are, carefully remove all areas that have not perfectly hardened. If widespread defects are present, consider applying an additional coat of Floorzero.

③ Layer → Base finishing coat

Preparation

- Pour part B following the catalysis ratio part A : part B = 4 : 1 (by weight). Mix with a helicoidal agitator until a smooth mixture is obtained.
- After carefully mixing for the first time, run a square-sided trowel along the sides and bottom of the bucket to mix all parts left unmixed by the agitator, then mix again.

Cementoresina 1

Coloured base coat for **Cementoresina** floors.



Products

Pack – (4+1) 5 kg



Coverage

≈ 750 g/m²

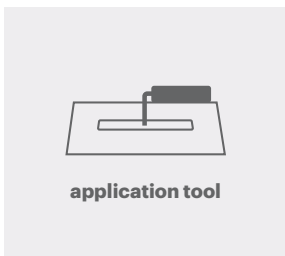

Tools

American spreader

Trowel 2

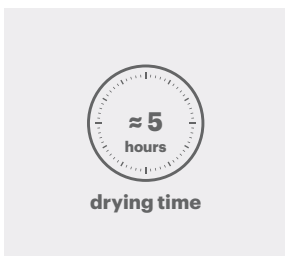

Time

Waiting time for overlaying: ≈ 5 hours (+30 °C), ≈ 10 hours (+10 °C)

③ Layer → Base finishing coat

Cementoresina 1



→ The **Floorzero** layer must be carefully prepared. Collect the excess quartz, then sand with a mechanical buffer (carborundum disk, followed by 36 grain) and thoroughly vacuum to remove any sanding residue.



→ Pour part B respecting the mixing ration $A : B = 4 : 1$. Mix with a helicoidal agitator until a smooth mixture is obtained.
→ After carefully mixing for the first time, run a trowel along the sides and bottom of the bucket to mix all parts left unmixed by the agitator, then mix again.



→ Before the application check that **Floorzero** has no defects and imperfections and that the **Net 90** mesh is not showing.

Tip: any light depressions or small imperfections must be grouted before proceeding with the complete application.



→ Smooth the product on the **Floorzero** support layer using small semi-circular movements of the trowel without leaving crests or ridges.

Tip: apply the product with a low angle of inclination of the trowel, so that the blade will slide on the inert material contained in the product.

④ Layer →

Decorative finishing layer

Preparation

- Pour part B following the catalysis ratio part A : part B = 2.5 : 0.5 (by weight). Mix with a helicoidal agitator until a smooth mixture is obtained.
- After carefully mixing for the first time, run a square-sided trowel along the sides and bottom of the bucket to mix all parts left unmixed by the agitator, then mix again.

Cementoresina 2

Coloured decorative finishing product for **Cementoresina** continuous floors.



Products

Pack – (2.5+0.5) 3 kg



Coverage

≈ 500 g/m²

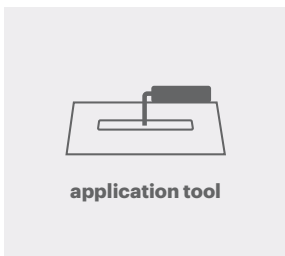

Tools

American spreader

Trowel 2

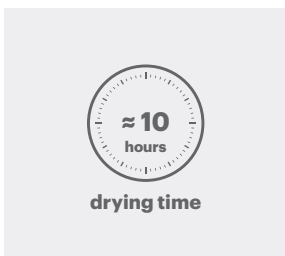

Time

Waiting time for overlaying: ≈ 10 hours (+20 °C), ≈ 24 hours (+10 °C)

④ Layer → Decorative finishing layer

Cementoresina 2



→ Sand the **Cementoresina 1** layer with a floor buffer (120 grain) and thoroughly vacuum to remove sanding residues.

Tip: the grip of Cementoresina 1 is essential for the application of Cementoresina 2. When sanding do not excessively insist.



→ Pour part B respecting the mixing ration $A : B = 2.5 : 0.5$. Mix with a helicoidal agitator until a smooth mixture is obtained.

→ After mixing for the first time, run a square-sided trowel along the sides and bottom of the bucket to mix all parts left unmixed by the agitator, then mix again.



→ Smooth the product on the floor using small semi-circular movements of the trowel without leaving crests or ridges. The trowel must slide over the preceding layer so that the product is completely smoothed off.



→ On steps, finish the product being careful to cover the corner leaving a small excess of product that will be removed by subsequent sanding.

Tip: be careful not to leave any crests or ridges in the antiskid R11 cycle (Cementoresina 2 remains visible as it is the cycle's last layer).

⑤ Layer → Protective gel

Preparation

- Pour part B respecting the catalysis ratio part A : part B = 2 : 1 (in weight) and mix with a helicoidal agitator until a smooth mixture is obtained.
- After carefully mixing for the first time, run a small scraper along the sides and bottom of the bucket to mix all parts left unmixed by the agitator. After cleaning the small scraper, mix again.

Cementoresina Gel

Transparent gel for **Cementoresina** and **Cementoresina Wall** floors and coverings.

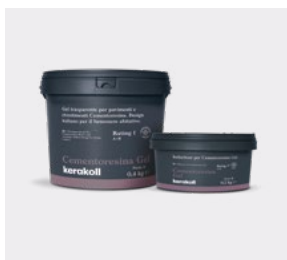

Products

Pack – (0.4+0.2) 0.6 kg



Coverage

≈ 90 g/m²



Tools

Transparent plastic trowel

Trowel 3

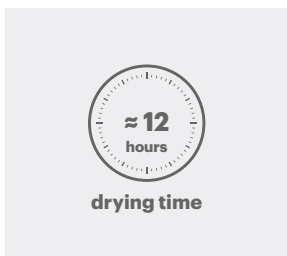

Time

Waiting time for overlaying: ≈ 12 hours (+30 °C), ≈ 24 hours (+15 °C)

⑤ Layer → Protective gel

Cementoresina Gel



→ Be careful not to dirt **Cementoresina 2** with any plastic or metallic parts of shoes, knee pads or tools.

Tip: remove any stains or marks with a cloth soaked in Keragrip Eco Pulep.



→ Sand the **Cementoresina 2** layer with a floor buffer (120 grain) and thoroughly vacuum to remove sanding residues.

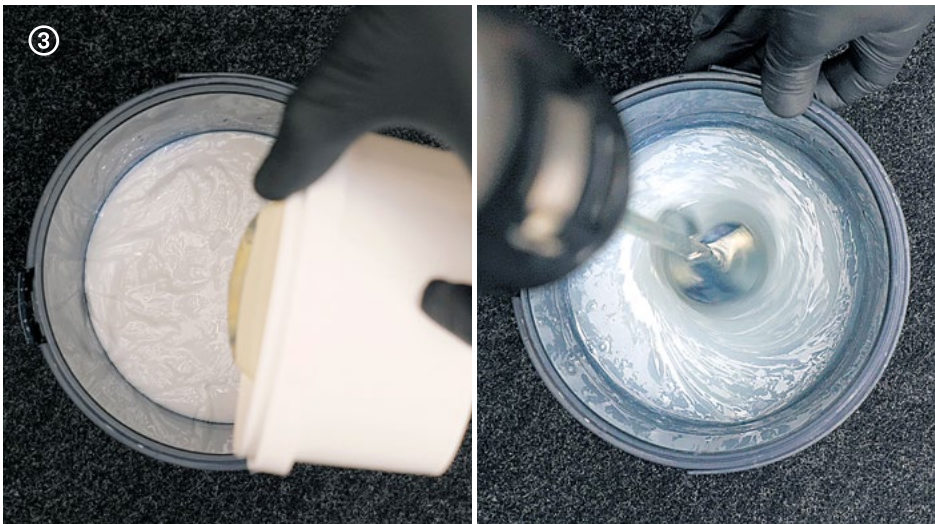

- Pour part B respecting the mixing ration $A : B = 2 : 1$. Mix with a helicoidal agitator until a smooth mixture is obtained.
- After carefully mixing for the first time, run a scraper along the sides and bottom of the bucket, then mix again.



- Smooth the product on the floor using small semi-circular movements of the trowel without leaving crests or ridges. The trowel must slide over the preceding layer so that the product is completely smoothed off.

Tip: pass over again with a short-bristle roller to remove any excess.

⑤ Layer → Protective gel

Cementoresina Gel



→ In case of stains or marks when applying **Cementoresina Gel**, clean with a cloth soaked in **Keragrip Eco Pulep**; then apply again **Cementoresina Gel** in the same spot and proceed with the application.



APPLICATION ON STAIRS AND STEPS

→ After thoroughly sanding **Cementoresina 2**, spread **Cementoresina Gel** using a small short-bristle roller; take care to evenly lay the product in order to avoid accumulations.



→ **Waiting time before sanding and overapplication ≈ 12 hours (+30 °C)
/ ≈ 24 hours (+15 °C)**

⑥ Layer → Transparent protective

Preparation

- Shake part A before use and pour it into a clean tray.
- Add the hardening compound whilst stirring in the ratio part A : part B = 5 : 1.
- Mix well, then dilute 10% using clean water and mix again.

Microresina Xtreme

Transparent, water based micro-resin for the protection of **Cementoresina** and **Cementoresina Wall**.



Products

Pack – (1+0.2) l and (2.5+0.5) l



Coverage

≈ 120 ml/m² for two coats

Dilution – max 5 - 10%



Tools

Roller

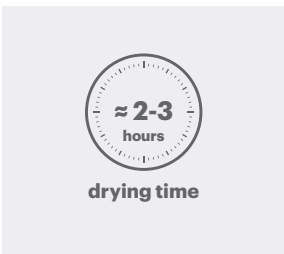

Time

Waiting time between subsequent coats: ≥ 2-3 hours

If more than 12 hours elapse, lightly sand with **Softpad**.

⑥ Layer → Transparent protective

Microresina Xtreme



→ Sand **Cementoresina Gel** with a mechanical buffer with **Softpad felt pad**, and thoroughly vacuum to remove sanding residue.

Tip: if crests or accumulations are present, sand with a rotating orbital sander with 180 - 220 abrasive pad.



→ Shake part A before use and pour it into a clean tray.

→ Add the hardening compound whilst stirring in the ratio part A : part B = 5 : 1. Mix well, then dilute 10% using clean water and mix again.



- Apply 2 coats of **Microresina Xtreme** with **Roller Plus** or a flat brush respecting the coverage of $\approx 60 \text{ ml/m}^2$ per coat.
- Waiting time for the overlaying of successive coats of **Microresina Xtreme**: $\approx 2 - 3$ hours.



- If the 2nd coat is applied within 12 hours it is not necessary to sand the surface. If a period of over 12 hours has passed, sand with **Softpad**.
- Tip: ready for use in domestic environments $\approx 2 - 4$ days (light foot traffic), do not cover, do not wash and do not walk on for at least 48 hours.



Cementoresina Wall

Cementoresina Wall

Use

Cementoresina Wall is ideal for:

- walls, shower coverings, Turkish baths coverings, bathtubs, shelves, basin tops and other architectural elements
- for internal use, in domestic and commercial environments.

Cementoresina Wall

Resin covering with a coloured-body trowelled texture and high-performance natural finish.

Cementoresina Wall's texture has high aesthetic qualities, featuring irregularities, marbling, material vibrations and other imperfections typical of hand-crafted products.

It creates a fascinating and elegant atmosphere in just 3 mm of thickness.



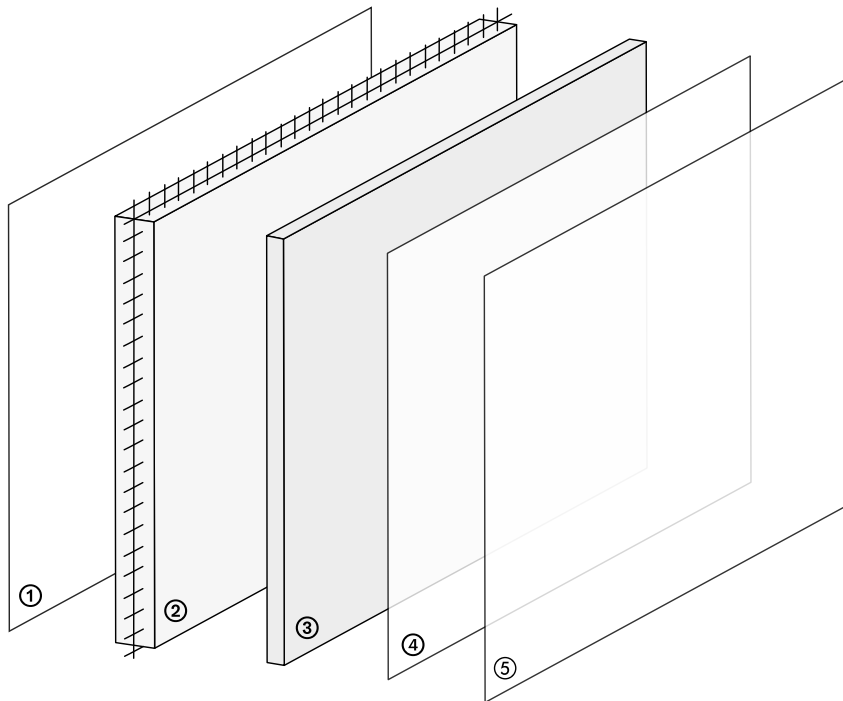

① Layer → Priming, according to the substrate

Universal Wall Primer

Keragrip Eco Pulep

② Layer → Structural substrate

Wallzero + Net 90

③ Layer → Decorative finishing layer

Cementoresina Wall

④ Layer → Protective gel

Cementoresina Gel

⑤ Layer → Transparent protective

Microresina Xtreme

① Layer → Priming

Preparation

Warnings about substrates

- The substrates must be dry and free from rising damp.
- Maximum residual moisture on cement-based and ceramic substrates: < 2% (< 1.7% with underfloor heating systems).
- Maximum residual moisture on gypsum-based substrates: < 0.5% (< 0.2% with underfloor heating systems).
- Temperature range for application from +10 °C to +30 °C.
- Relative environmental humidity ≤ 75%.

Suitable substrates

- Cement-based plasters.
- Existing ceramic covering.
- Substrates made with fibre-cement panels.
- Gypsum-base plasters.
- Plasterboard panels.
- Substrates made with plywood, MDF, and HDF panels.

Universal Wall Primer

Eco-friendly, organic preparation coat for priming and consolidating absorbent substrates.



Products

Pack - 1 l - 5 l - 10 l



Coverage

≈ 150 - 200 ml/m²



Tools

Roller

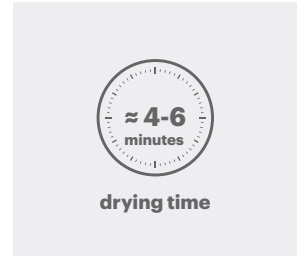

Time

Waiting time for overlaying: 4 - 6 hours

Keragrip Eco Pulep

Eco-friendly, organic preparation coat for ceramic coverings.



Products

Pack - 1 l - 10 l



Coverage

≈ 30 ml/m²

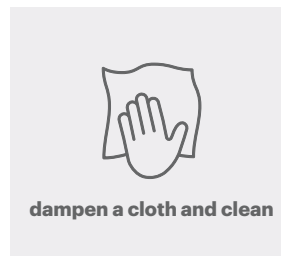

Tools

Cloth

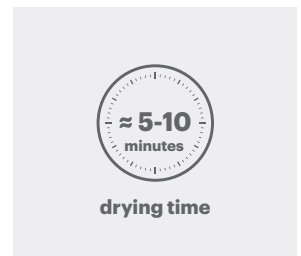

Time

Waiting time for overlaying: 5 - 10 minutes

① Layer → Priming

Universal Wall Primer



CEMENT, LIME AND GYPSUM-BASED PLASTERS AND FINISH PLASTERS AND SUBSTRATES MADE WITH PLASTERBOARD PANELS

→ Prime substrate with **Universal Wall Primer**.

Tip: when preparing furniture and joinery made with plywood and MDF panels, apply EP21 primer; make sure that the back of the panel to be covered with Wallzero has been primed as well, in order to avoid moisture absorption or subsequent water infiltrations. Dust with Quarzo 1.3 while still wet. Wait until the primer has completely hardened, then sand with a rotating orbital sander with 80 grain sandpaper and vacuum.



CERAMIC, GLASS MOSAIC AND NATURAL STONE PREVIOUS COATINGS

→ Prime the ceramic substrate with **Keragrip Eco Pulep** adhesion promoter.

Tip: when preparing and filling any chases on vertical coverings, we recommend to use thick layers of expansive polyurethane foam. Carefully moisten the substrate, let the foam expand; when it has dried (usually after 2-3 hours), remove any excess with a scraper for plasters/renders.

Wallzero may then be used on the polyurethane foam prepared as such. To repair even thicknesses on walls, we recommend to use dry panelling.

② Layer → Structural substrate

Preparation

- Mix part A and part B respecting the mixing ratio A : B = 100 : 14. Add water until the required consistency is reached $\approx 3 \text{ l} / 1 \text{ bag (25 kg)}$.
- Pour the correctly weighed quantity of **Wallzero** part B into a clean container together with a quantity of water equal to $\approx 3/4$ of what is required.
- Gradually add **Wallzero** part A to the container, mixing with a metal agitator. Add more water until the desired consistency is obtained.

Wallzero

Innovative mineral matrix composite, structural base layer for **Cementoresina Wall** and for the repair of irregular substrates.



Products

Pack – (25+3.5) kg



Coverage

≈ 3.4 kg/m² per 2 mm of thickness



Tools

American spreader

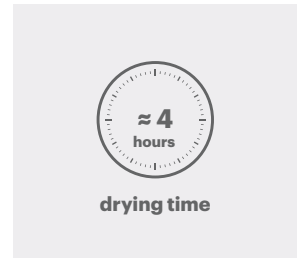

Time

Waiting time for overlaying:
≈ 4 hours (+20 °C)
≈ 8 hours (+10 °C)

Net 90

Glass fibre reinforcement mesh.



Products

Pack – 50 m



Coverage

≈ 1.1 m/m²

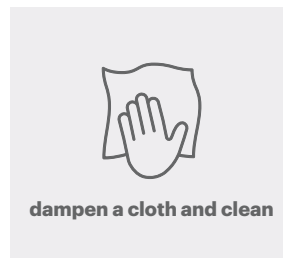

Tools

Cloth

② Layer → Structural substrate

Wallzero



→ First prepare the layers of **Net 90** mesh, cutting it where needed.



→ Overlap edges for at least 10 cm.



→ **Wallzero** is prepared by mixing together parts A and B, respecting the mixing ratio $A : B = 100 : 14$. Add water until the required consistency is reached $\approx 3 \text{ l} / 1 \text{ bag (25 kg)}$.

Tip: pour the correctly weighed quantity of Wallzero part B into a clean container together with a quantity of water equal to $\approx 3/4$ of what is required. Gradually add Wallzero part A to the container, mixing with a metal agitator. Add more water until the desired consistency is obtained. When working by yourself and/or in case of small walls, it is recommended to mix small quantities of material.

E.g.: part A 5 kg, part B 0.7 kg + ≈ 0.5 kg of water.

② Layer → Structural substrate

Wallzero



- Insert **Aquastop Flangia 120x120** wherever the system is interrupted by pipes, taps, etc. to prevent possible infiltrations.
- To avoid infiltrations and guarantee the surface continuity, insert the **Aquastop 120** band in all wall-floor corner joints . Spread a slightly exceeding quantity of **Wallzero** and fix the band and/or the flanges pressing them with the scraper; remove any excess. Finish again the band and/or the flange, covering it with **Wallzero**.



→ Use straight, rigid PVC or aluminium corner pieces to reinforce the edges when it is necessary to incorporate edge beads into **Wallzero** in showers, bathtubs, Turkish baths, washbasin recesses or counters.

Tip: we recommend using PVC edge beads.

N.B. In damp environments or showers, do not use galvanized steel sheet edge beads. When sanding there is a high risk of removing the galvanizing.

② Layer → Structural substrate

Wallzero



→ Spread the product with a notched trowel leaving some ≈ 1 m wide strips.



→ Lay the mesh on the product while it is still wet and overlap it with the one next to it for 10 cm; then smooth with a finishing trowel, level to cover the **Net 90** fibreglass reinforcing mesh and remove any excess.



- Wait ≈ 4 hours before applying subsequent coats
- In case of crests or imperfections, sand with a rotating orbital sander (40-60 grain) and thoroughly clean from any sanding residue.



- After ≈ 3 hours, dampen the 1st coat of **Wallzero**, then apply a second coat smoothing the product with small strokes of the trowel in order to obtain a flat and even surface.

Tip: should the Net 90 mesh still be visible after applying the previous two coats, apply a further coat.

③ Layer →

Decorative finishing layer

Preparation

- Pour part B following the catalysis ratio Part A : Part B = 3 : 0.4 (by weight). Mix with a helicoidal agitator until a smooth mixture is obtained.
- After carefully mixing for the first time, run a scraper along the sides and bottom of the bucket to mix all parts left unmixed by the agitator, then mix again.

Cementoresina Wall

Coloured finishing product for **Cementoresina Wall** vertical coverings.



Products

Pack – (3+0.4) 3.4 kg



Coverage

≈ 1.2 kg/m² for two coats (600 g/m² per coat)

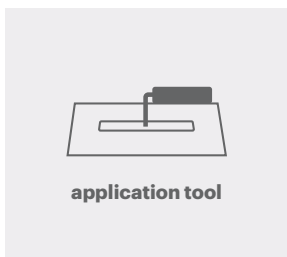

Tools

American spreader

Trowel 2

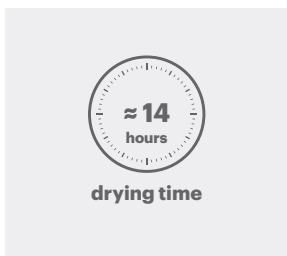

Time

Waiting time for overlaying: ≈ 14 hours (+30 °C), ≈ 24 hours (+10 °C)

③ Layer → Decorative finishing layer

Cementoresina Wall

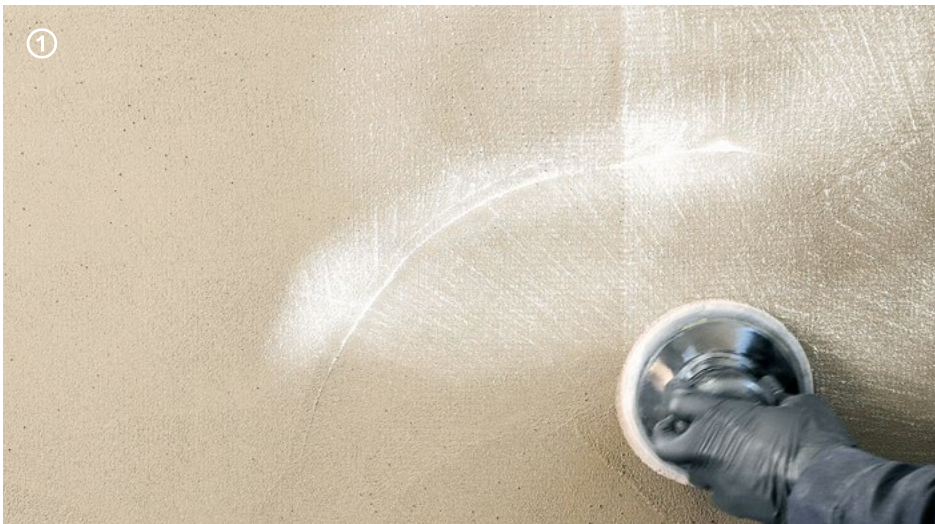

→ Before the application, check that **Wallzero** is perfectly levelled, that imperfections of the substrate have been covered and removed, and that the **Net 90** mesh is not showing. Sand **Wallzero** with a rotating orbital sander (40 grain) and clean any sanding residue.



→ Pour part B following the catalysis ratio $A : B = 3 : 0.4$. After carefully mixing with a helicoidal agitator for the first time, run a scraper along the sides and bottom of the bucket to mix all parts left unmixed by the agitator. After cleaning the scraper, mix again.



→ Evenly smooth the product using small semi-circular movements of the trowel without leaving crests or ridges.

Tip: apply with the trowel tilted so that the blade can slide on the inert material contained in the product.



→ Make sure that **Wallzero** is completely covered, paying particular attention to covering corners and edges.

→ Avoid creating crests and accumulation of material, in order to reduce the areas in which sanding will be necessary.

③ Layer → Decorative finishing layer

Cementoresina Wall

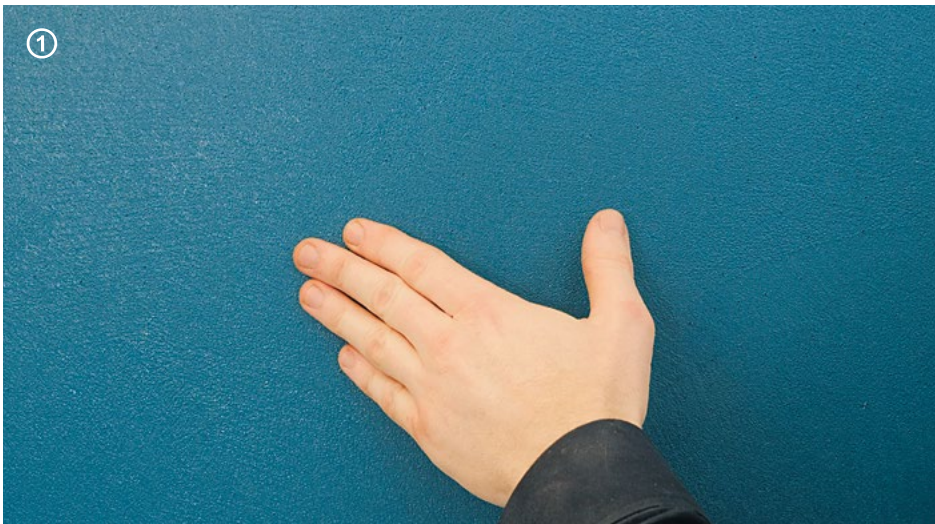

→ When applied as 1st coat, **Cementoresina Wall** can be overlaid after 14 hours from its initial application. The layer can be overlaid even if it is still “tacky” on the surface.



→ If any visible crests or accumulation of material form at the corners when applying the 1st coat of **Cementoresina Wall**, they must be removed by using the trowel blade or a grade 60 sandpaper, either by hand or using a sander.

Tip: be particularly careful not to break through the 1st coat so as to make the Wallzero layer visible.



- Smooth the product using small semi-circular movements of the trowel without leaving crests or ridges. The trowel must slide over the preceding layer so that the product is completely smoothed off.
- In corners, avoid creating crests and accumulation of material, in order to reduce the areas in which sanding will be necessary.
- Check carefully that the whole of the surface has been evenly covered.

④ Layer → Protective gel

Preparation

- Pour part B respecting the catalysis ratio part A : part B = 2 : 1 (in weight) and mix with a helicoidal agitator until a smooth mixture is obtained.
- After carefully mixing for the first time, run a small scraper along the sides and bottom of the bucket to mix all parts left unmixed by the agitator. After cleaning the small scraper, mix again.

Cementoresina Gel

Transparent gel for **Cementoresina** and **Cementoresina Wall** floors and coverings.



Products

Pack – (0.4+0.2) 0.6 kg



Coverage

≈ 90 g/m²

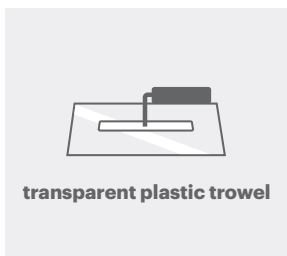

Tools

Transparent plastic trowel

Trowel 3

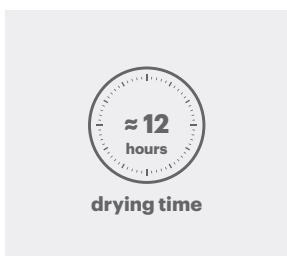

Time

Waiting time for overlaying: ≈ 12 hours (+30 °C), ≈ 24 hours (+15 °C)

④ Layer → Protective gel

Cementoresina Gel

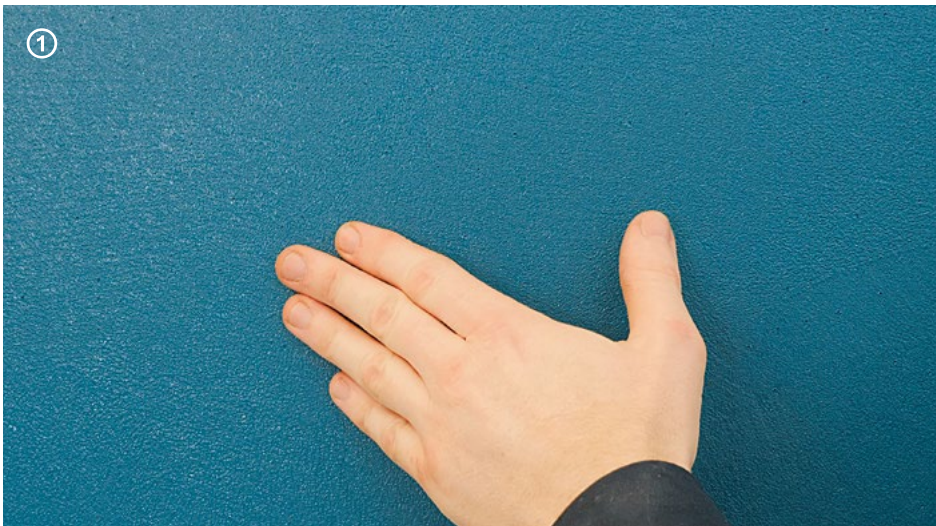

- **Cementoresina Wall** coloured finishing layer can be overlaid after 14 hours from its initial application.
- **Cementoresina Wall** can be overlaid with **Cementoresina Gel** even if it is still “tacky” on the surface.



→ If any crests or flashes form at the corners when applying **Cementoresina Wall**, they must be removed by carefully sanding either with a sander or by hand using grade 100 - 120 sandpaper; take great care not to break through the coloured layer and not to “dirty” the surface with the sandpaper if it ever becomes clogged.

Tip: in case of stains or marks, clean the surface with a cloth soaked in Keragrip Eco Pulep before applying the next layer.

If the coloured layer should break through when sanding, apply a further coat of Cementoresina Wall before applying the Cementoresina Gel sealing layer.

④ Layer → Protective gel

Cementoresina Gel

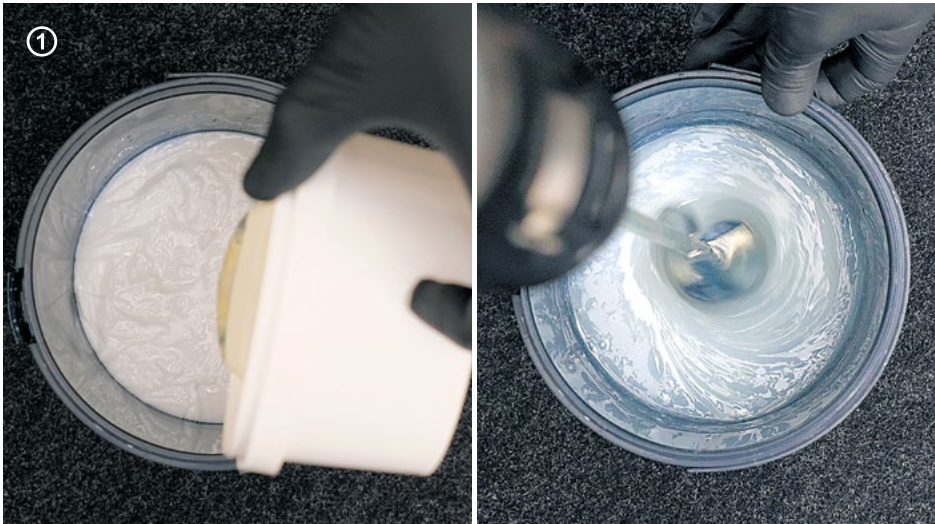

→ Pour part B following the catalysis ratio Part A : Part B = 2 : 1 (by weight).

→ Mix with a helicoidal agitator until a smooth mixture is obtained.

Tip: after carefully mixing for the first time, run a small square-sided scraper along the sides and bottom of the bucket to mix all parts left unmixed by the agitator. After cleaning the small scraper, mix again.

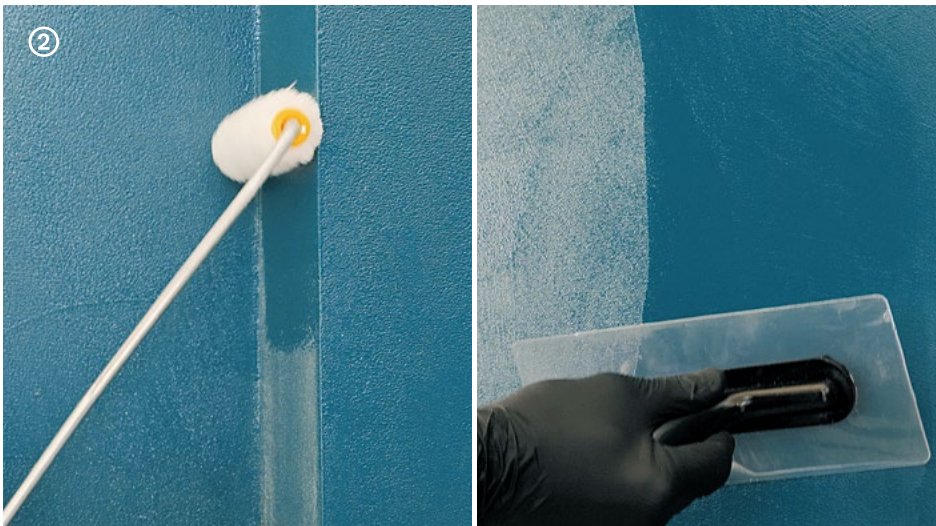

- Apply the product smoothing it off completely with a Trowel 3 smooth transparent trowel or a short-bristle roller (if need be, pass over again with the trowel in order to eliminate any roller strokes).
 - Smooth the product on the floor using small semi-circular movements of the trowel without leaving crests or ridges.
- Tip: avoid creating crests and accumulation of materials in corners.

⑤ Layer → Transparent protective

Preparation

- Shake part A before use and pour it into a clean tray.
- Add the hardening compound whilst stirring in the ratio part A : part B = 5 : 1.
- Mix well, then dilute 10% using clean water and mix again.

Microresina Xtreme

Transparent, water based micro-resin for the protection of **Cementoresina** and **Cementoresina Wall**.



Products

Pack – (1+0.2) l and (2.5+0.5) l



Coverage

≈ 120 ml/m² for two coats

Dilution – max 5-10%

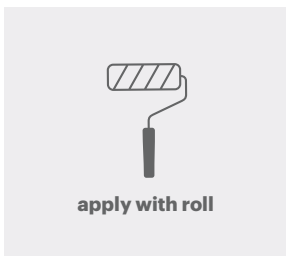

Tools

Roller

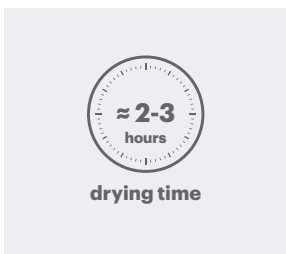

Time

Waiting time between subsequent coats: ≥ 2-3 hours

If more than 12 hours elapse, lightly sand with **Softpad**.

⑤ Layer → Transparent protective

Microresina Xtreme



→ Sand **Cementoresina Gel** with a rotating orbital sander with **Softpad** felt disk. Vacuum thoroughly to remove sanding residue.

Tip: if crests or accumulations are present, sand with a rotating orbital sander with 180 - 220 abrasive pad.



→ Shake part A before use and pour it into a clean tray.

→ Add the hardening compound whilst stirring in the ratio part A : part B = 5 : 1.

→ Mix well, then dilute 10% using clean water and mix again.

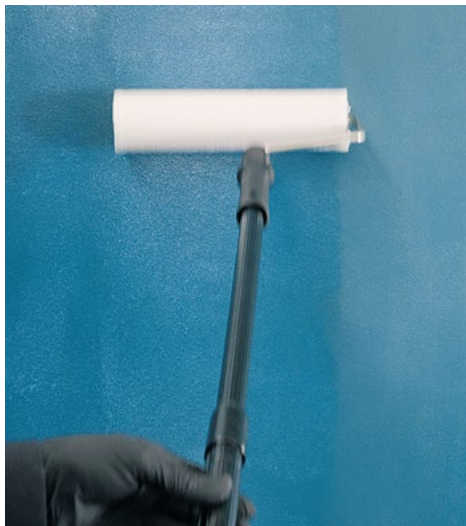
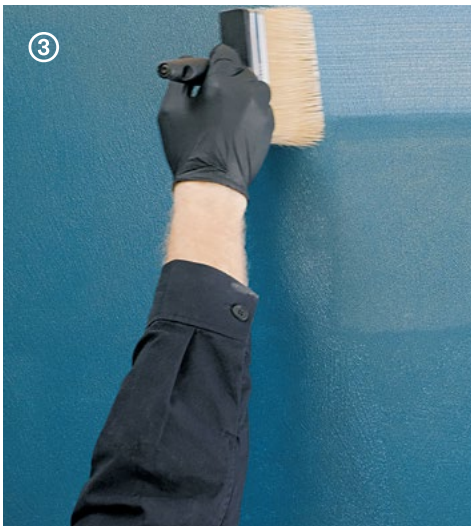

- Apply 2 coats of **Microresina Xtreme** with **Roller Plus** respecting the coverage of $\approx 60 \text{ ml/m}^2$ per coat.
- Waiting time for the overlaying of successive coats of **Microresina Xtreme**: $\approx 2 - 3$ hours.



- If the 2nd coat is applied within 12 hours it is not necessary to sand the surface.
- If a period of over 12 hours has passed, sand with **Softpad**.

⑤ **Layer** → **Transparent protective**

Microresina Xtreme



→ After the application, use **Hyperflex Hybrid** clear transparent sealant or **Silicone Color** to seal plaques, vents, shower cabinets and drains in environments with frequent contact with water.

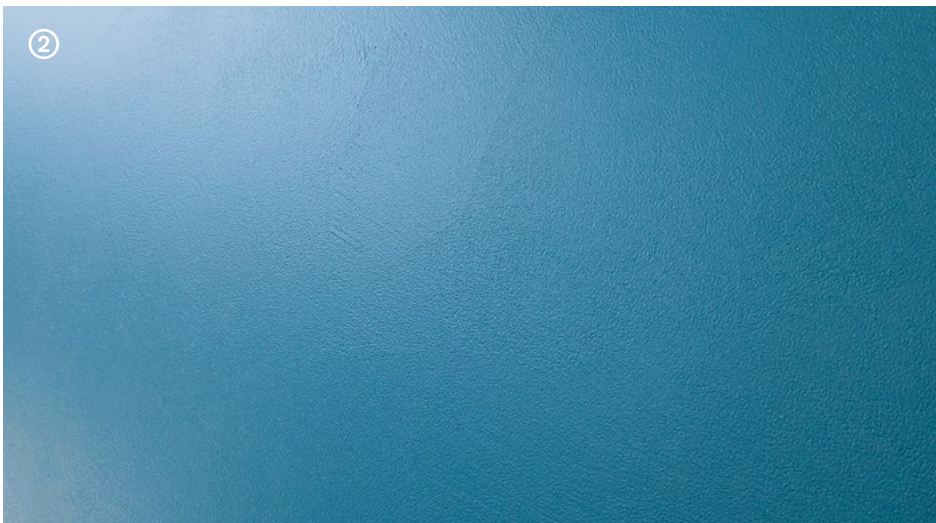

→ Ventilate the area during the drying phase. The use of a fan is recommended.

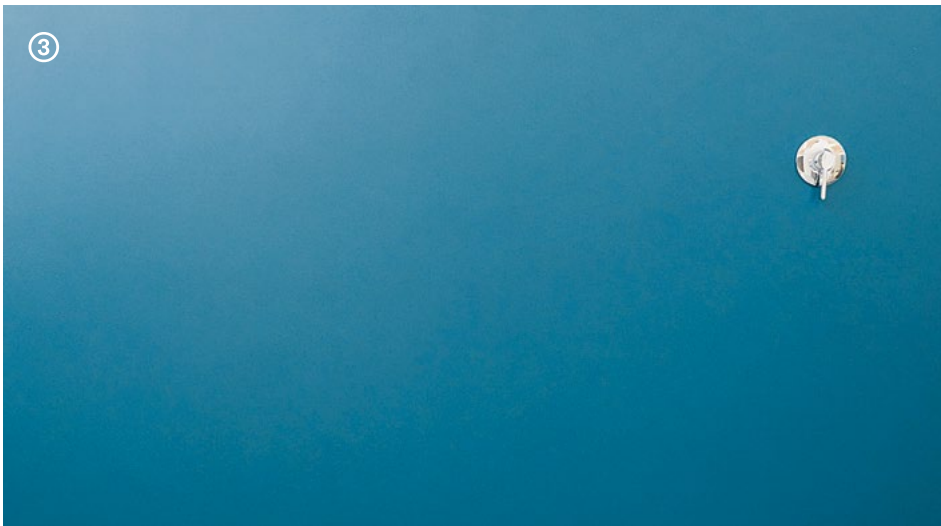

Tip: washing and contact with water \approx 48 h.

Surfaces and Uses

Surfaces

Paints

Absolute
Decor

Resin-based coating materials

Decorative coverings
Wallcrete Living
Wallpaper Living
Patina Living
Stripe Living

Technical coverings*

Wallcrete
Wallpaper
Patina

Microresina

Microresina
Microresina Floor
Microresina Parquet

Cementoresina

Cementoresina
Cementoresina Wall

Legno+Color

Legno+Color S, M, L

Finishes for external application

Outdoor Paint
Outdoor Plaster

Skirting board

Invisibile

Use

Walls and ceilings

Absolute
Decor

Decorative walls

Wallcrete Living
Wallpaper Living
Patina Living
Stripe Living

Technical walls*

Wallcrete
Wallpaper
Patina
Cementoresina Wall

Floors

Cementoresina
Legno+Color S, M, L
Microresina Floor
Microresina Parquet

Re-color**

Microresina

External façades

Outdoor Paint
Outdoor Plaster

* Walls of bathrooms and kitchens.

** Doors, internal and external fixtures, joinery and ceramic coverings.

N.B.

This Site manual has been drafted on the basis of the best technical and practical knowledge of Kerakoll S.p.A.

It is, however, a set of guides and information of a general nature that do not consider the real situations of individual structures; therefore, the coverage information is to be considered merely indicative.

Kerakoll does not intervene directly in the building site conditions, the specific design of the project, and the execution of the work; the information and guidelines mentioned here do not commit Kerakoll in any way.

The designer in charge is responsible for the entire structural design in accordance with Italian Ministerial Decree 17/01/2018 and its amendments or additions.

All rights reserved. © Kerakoll. All rights to the content of this publication are reserved in accordance with applicable law.

The duplication, publication, and distribution, in full or in part, of all material contained herein, are expressly forbidden without written authorization.

Additions and/or amendments to this information may be made over time by KERAKOLL Spa; for the latest version, see www.kerakoll.com.

KERAKOLL Spa shall therefore be liable for the validity, accuracy and updating of information provided only when taken directly from its institutional website. For information on the product safety data, refer to the corresponding sheets provided in accordance with the law along with the health labelling on the packaging. Finally, it is advisable to perform a preliminary test of each product to verify its suitability for your purposes.

Kerakoll Spa
via dell'Artigianato 9
41049 Sassuolo (MO) Italy
T +39 0536 816 511
info@kerakoll.com

Kerakoll Brera Studio
via Solferino 16
20121 Milano (MI) Italy
T +39 02 620 867 81

kerakoll

kerakoll.com